

6

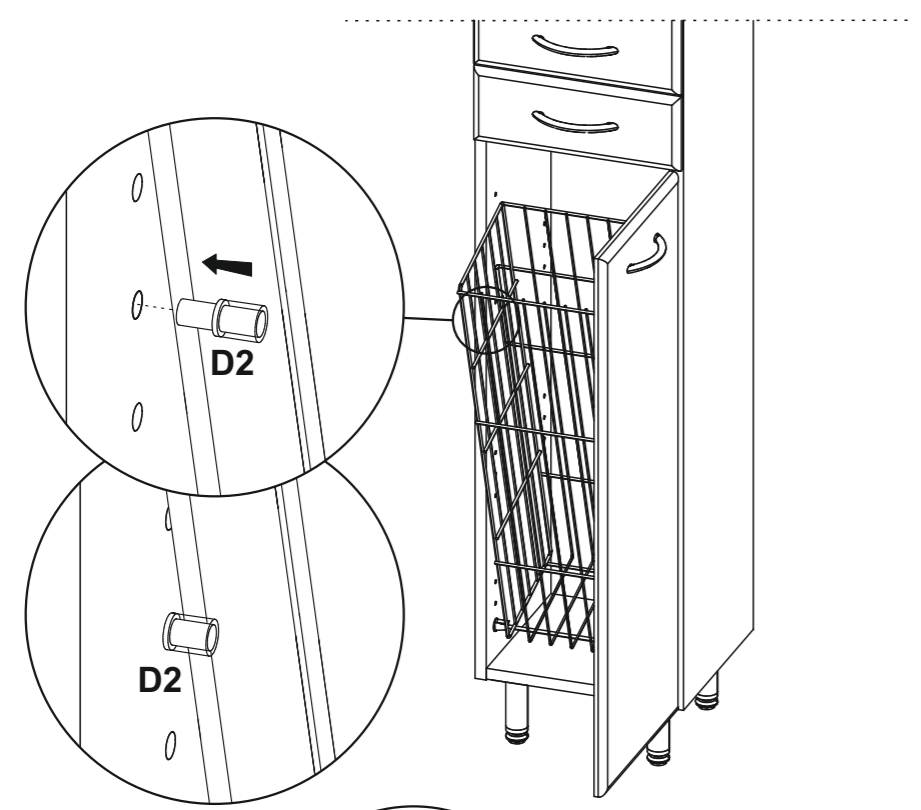

7

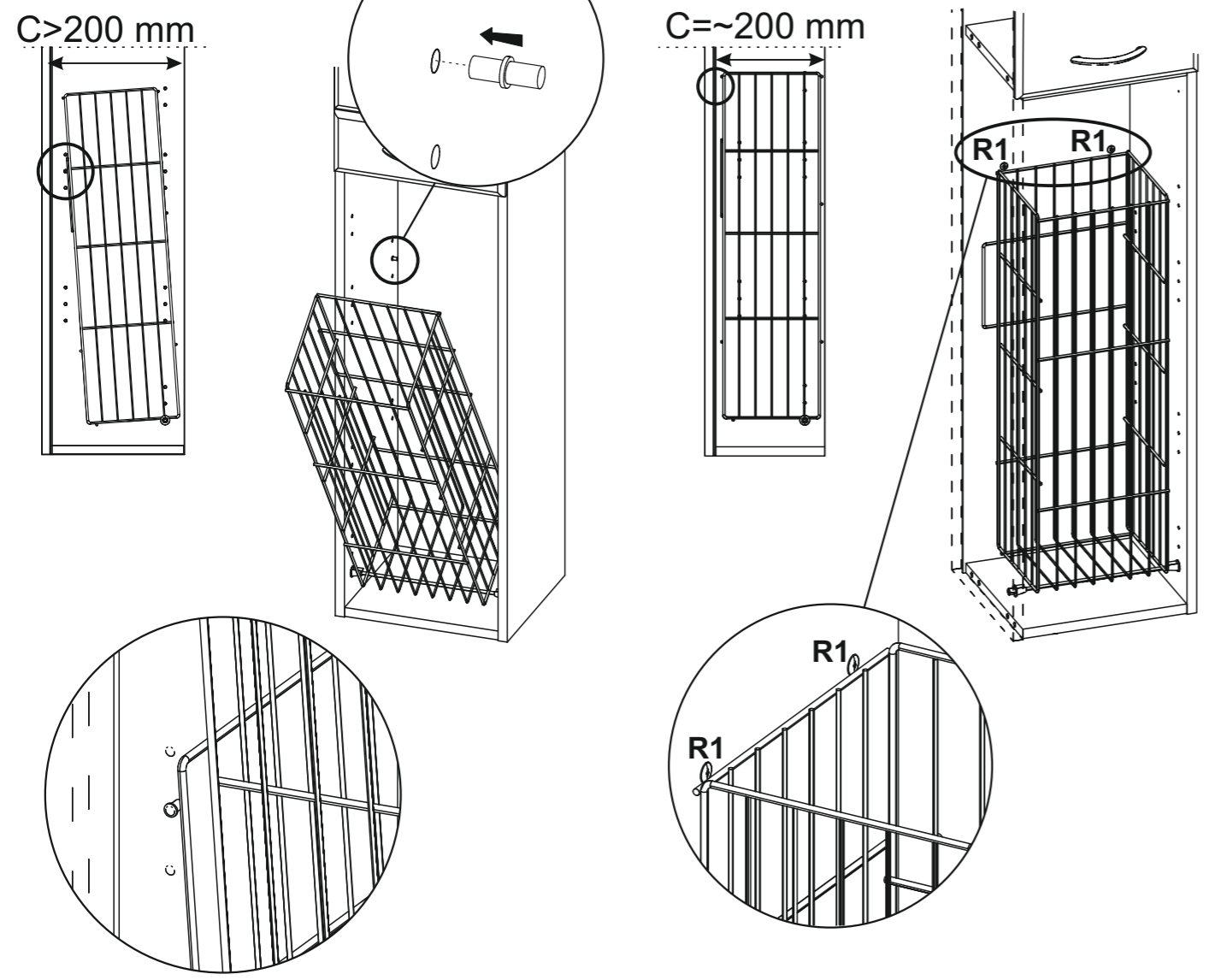

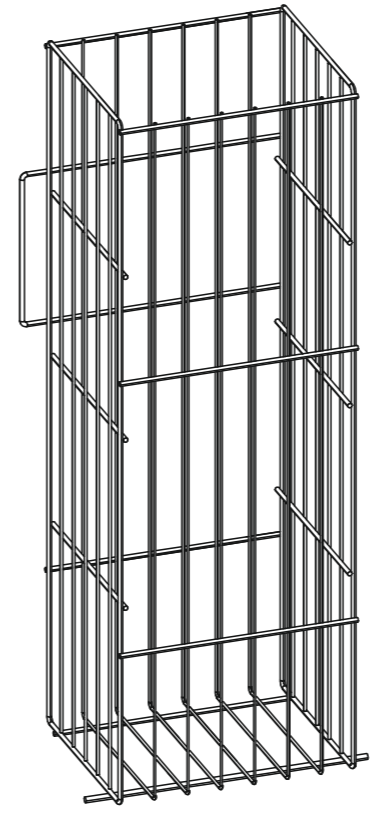

165450

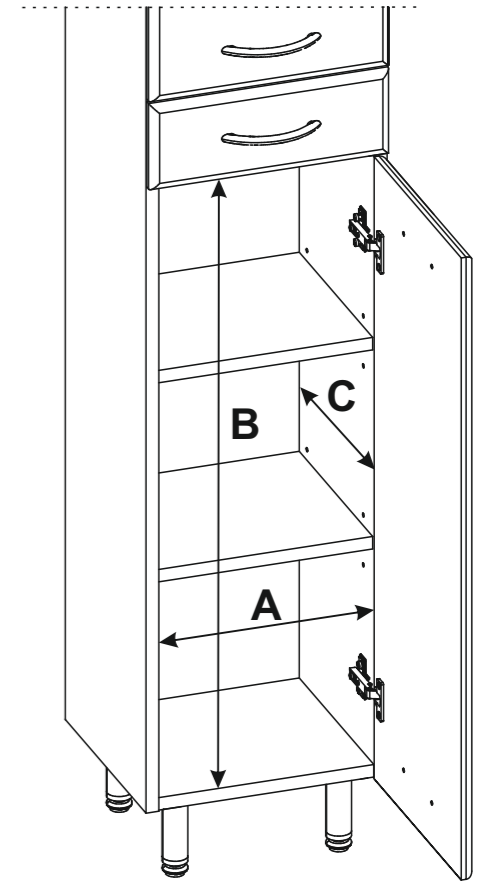

A=268 +/-1mm  
 B= min. 720 mm  
 C= min. 200 mm

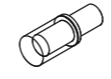
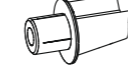

D2	D9	R1
		
x 1	x 2	x 2

